

Locally Operated Monitor Valve

Model: FP 405-11

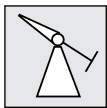

Typical Applications



Fire hydrant and monitor valves



Hydraulic remote controlled systems



zone isolating valve



Manual operated flood valve



Hydraulically operated hydrants

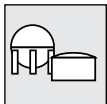

Gas & oil storage tanks

Features and Benefits

- **Quick & easy operation** – Requires only ¼ turn of the pilot valve handle
- **One-piece molded elastomeric moving part** – No maintenance required
- **In-line, quick cover removal** – Minimal downtime
- **Simple design** – Cost effective
- **Unobstructed flow path** – No supporting ribs

Optional Features

- **Seawater service** (add FS as prefix to model)
- **Corrosive environment materials** (see last page)
- **Foam resistant materials and coatings**
- **Remote hydraulic control**

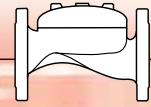

Operation

The BERMAD Model FP 405-11 is a simply designed, manually operated, on/off valve. It is particularly suited for monitors and industrial high capacity hydrants.

The Model FP 405-11 is held closed by line-pressure [1] applied to the control chamber [2] of the valve. The closed valve prevents the water (or water foam) from passing through the valve, keeping the downstream piping dry.

In the set position, the line pressure is applied to the control chamber of the valve. The pressure holds the main valve's diaphragm and plug against the valve seat [3]. Seal is drip tight. The Check Valve [4] traps high pressure peaks ensuring that the valve remains locked in the closed position to maintain drip tight sealing.

To open, a ¼ turn of the Manual Release Pilot [5] handle releases pressure from the control chamber through the opened Manual Release Valve. The diaphragm plug is then pushed open by the upstream force at its bottom, allowing water to flow into the system.

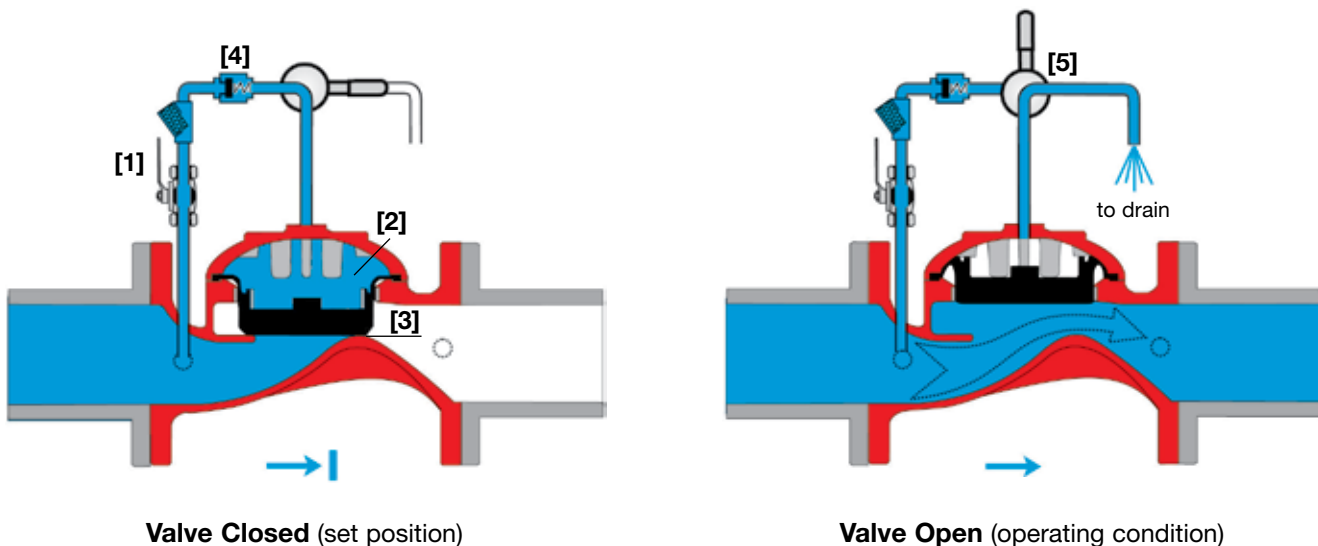

Engineer Specifications

- The valve shall be a hydraulic controlled, elastomeric type globe valve with a **rolling-diaphragm**.
- The valve shall have an **unobstructed flow path**, with no stem guide or **supporting ribs**.
- Valve actuation shall be accomplished by a fully peripherally supported, one-piece balanced rolling-diaphragm, vulcanized with a rugged radial seal disk. The diaphragm assembly shall be the only moving part.
- The valve shall have a removable cover for quick in-line service enabling all necessary inspection and servicing.
- The control trim shall consist of non-corrosive tubing and fittings, Manual Release Pilot, Check Valve and Y strainer.
- The valve trim shall be supplied as an assembly, pre-assembled and hydraulically tested at an ISO 9000 and 9001 certified factory.

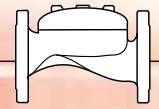

Local Manually Operated

Monitor Valve Model FP 405-II

This line pressure powered on/off valve replaces mechanical valves that often stick after long periods in the closed position. This valve is built to react smoothly and easily following any passage of time, from either the closed or open position.

System Components

- 1 - Main Valve, Bermad Model FP-405-11
- 2 - Manual Release Pilot
- 3 - Fire Monitor

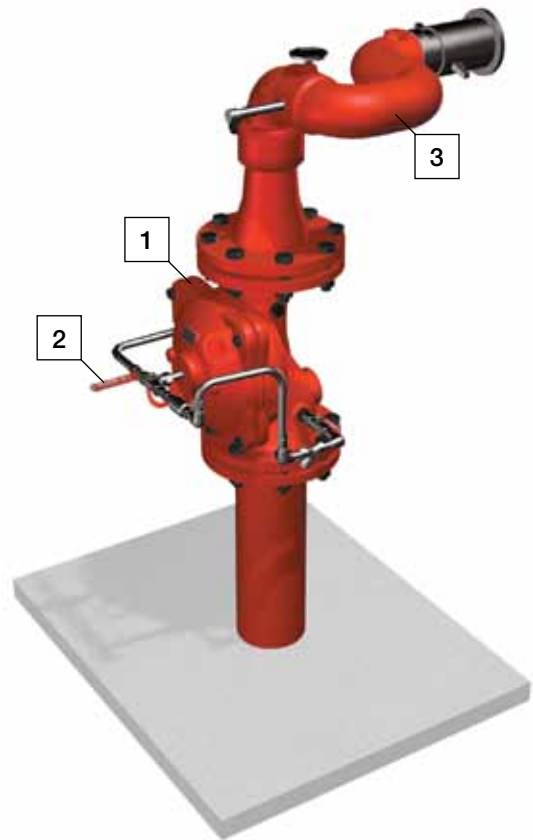

Remote Controlled Monitor System (with Foam Concentrate Injection)

Monitors located in hazardous areas should be operated from a remote panel in order to ensure their safe activation under fire conditions. Applying the Bermad Model FP 400E-5X to control Oscillating, Elevated and Pre-cooling spraying Monitors ensures quick response to any situation by an easy $\frac{1}{4}$ turn of the valve remoted pilot handle.

System Components

- 1 - Main Valve, BERMAD Model 400E-5X
- 2 - Remote Manual Release Pilot
- 3 - Remote Fire Monitor

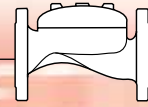

Technical Data

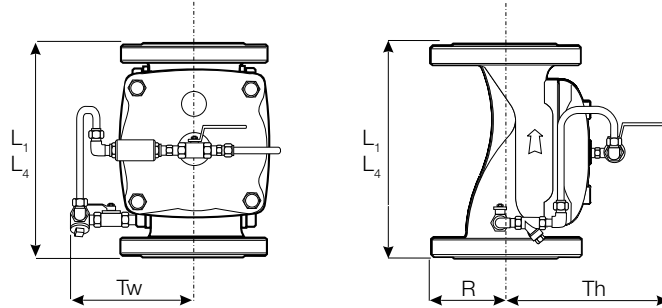

Size	1½", 2"		2½"		3"		4"		6"		8"		10"		
	mm	inch	mm	inch	mm	inch	mm	inch	mm	inch	mm	inch	mm	inch	
Dimensions	L ₁ ⁽¹⁾	205	8 ¹ / ₁₆	205	8 ¹ / ₁₆	257	10 ¹ / ₈	320	12 ⁵ / ₈	415	16 ⁵ / ₁₆	500	19 ¹¹ / ₁₆	605	23 ¹³ / ₁₆
	L ₄ ⁽²⁾	205	8 ¹ / ₁₆	N/A	N/A	250	9 ¹³ / ₁₆	320	12 ⁵ / ₈	N/A	N/A	500	19 ¹¹ / ₁₆	N/A	N/A
	Tw	318	12 ¹ / ₂	329	12 ¹⁵ / ₁₆	340	13 ³ / ₈	352	13 ¹³ / ₁₆	393	15 ¹ / ₂	423	16 ⁵ / ₈	443	17 ⁷ / ₁₆
	Th	232	9 ¹ / ₈	244	9 ⁵ / ₈	265	10 ³ / ₈	285	11 ¹ / ₄	360	14 ³ / ₁₆	415	16 ⁵ / ₁₆	413	16 ¹ / ₄
	R	78	3 ¹ / ₁₆	89	3 ¹ / ₂	100	3 ¹⁵ / ₁₆	112	4 ⁷ / ₁₆	140	5 ¹ / ₂	170	6 ¹¹ / ₁₆	203	8

- Notes:**
- L₁ is for flanged ANSI #150 and ISO PN16.
 - L₄ is for grooved end connections (Ductile Iron Only).
 - Provide adequate space around valve for maintenance.
 - Data is for envelope dimensions, specific component positioning may vary.

Connection Standard

- Flanged: ANSI B16.42 (Ductile Iron), B16.5 (Steel & Stainless Steel), B16.24 (Bronze)
- ISO PN16
- Grooved: ANSI/AWWA C606 for 2, 3, 4, 6 & 8"

Water Temperature

- 0.5 – 50°C (33 – 122°F)

Available Sizes

- 1½, 2, 2½, 3, 4, 6, 8, 10 & 12"

Pressure Rating

- Max. working pressure: 235 psi (16 bar)

Manufacturers Standard Materials

Main valve body and cover

- Ductile Iron ASTM A-536

Main valve internals

- Stainless Steel & elastomer

Control Trim System

- Brass control components/accessories
- Forged Brass fittings & Copper tubing

Elastomers

- Nylon fabric reinforced polyisoprene NR

Coating

- Electrostatic Power Coating Polyester, Red (RAL 3002)

Optional Materials

Main valve body

- Carbon Steel ASTM A-216-WCB
- Stainless Steel 316
- Ni-Al-Bronze ASTM B-148

Control Trim

- Stainless Steel 316
- Monel) and Al-Bronze
- Hastalloy C-276

Elastomers

- NBR
- EPDM

Coating

- High Build Epoxy Fusion-Bonded with UV Protection, Anti-Corrosion



Trädgårdsteknik AB
Helsingborgsvägen 578
262 96 ÄNGELHOLM
Telefon: 0431-222 90
Telefax: 0431-222 70
info@tradgardsteknik.se
www.tradgardsteknik.se
